

# AUTO INSTALLATION MANUAL

Welcome to DIRECTV. You have just joined the large family of clients who receive DIRECTV, the best entertainment for your home.



CURACAO



# LET'S GET STARTED!

1. Finding the best antenna site
2. Mast installation
3. Installing the dish
4. Cable connection
5. Locating the signal
6. Remote control
7. Channel 100 and on-screen balance
8. Need help?
9. Activation

# 1 Finding the best antenna site

## a. get familiar with the compass

You'll need:



compass



manual

To receive a DIRECTV signal you will need to point your antenna toward the DIRECTV satellite.

The DIRECTV satellite is located to the West 254 degrees. To find it, place the compass on the instruction manual on a flat surface.

WEST 254 DEGREES: THE ANTENNA SHOULD POINT THIS WAY

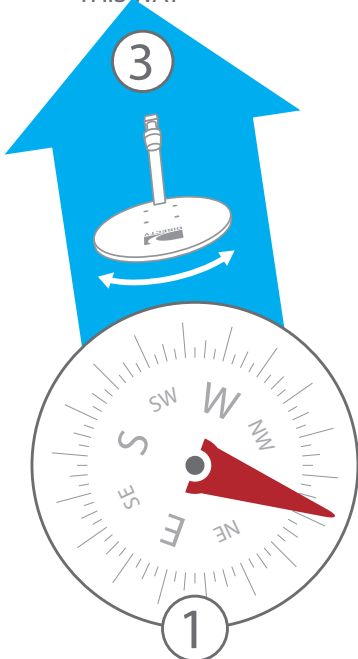

PLACE YOUR COMPASS HERE

POINT THE RED ARROW HERE

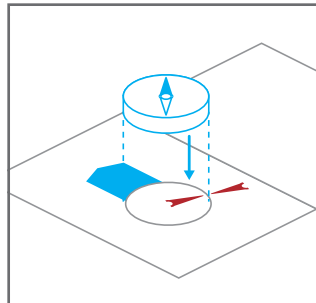

① Place the compass inside the drawing on this page.

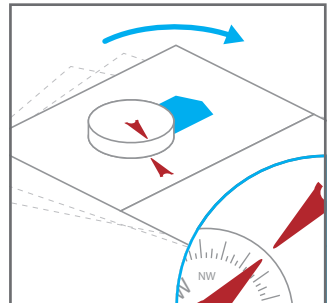

② Turn the manual and compass together until the needle points to the red mark.

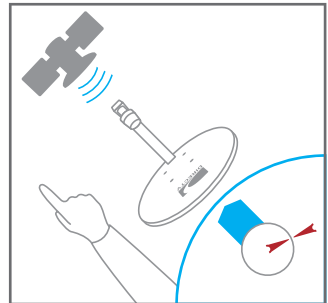

③ The blue arrow will indicate which way the antenna should point.

# 1 Finding the best antenna site

## b. look for the best spot

Now that you know where to aim your antenna, look for the best spot to install it.

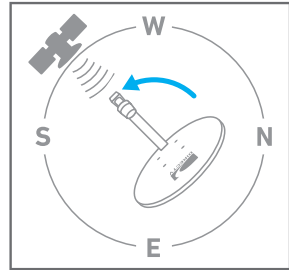
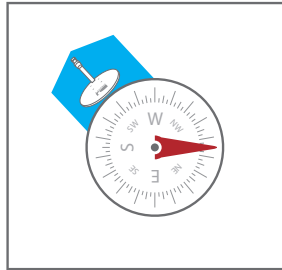

1. Look for an OPEN space facing West 254 degrees where you can install the antenna.

2. Make sure that nothing obstructs the signal.

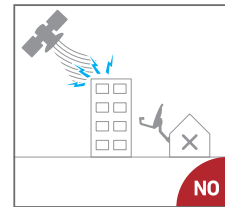
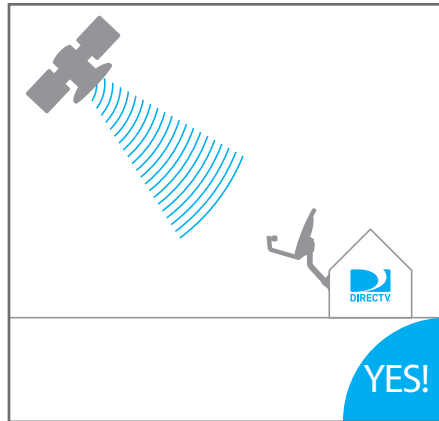

If you have neighbors with DIRECTV, use their antenna's position as a guide to placing your own. All antennas point towards the same place!

## BEFORE YOU CONTINUE REVIEW THE FOLLOWING

- ✓ The compass is pointing West 254 degrees.
- ✓ You've identified the best spot to install the antenna.
- ✓ There is nothing obstructing the signal.

■ You are now ready to proceed to Step 2.

# 2 Mast installation

## a. alignment

You'll need:



bubble level



mast



mast-wall screws



drill



8 and 10 mm drill bits



11 mm combination wrench



pencil

The mast holds your antenna. It must be **FIRMLY** installed and must be perfectly aligned in a level position to properly receive the signal.

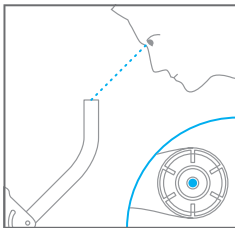

1. Look for the bubble located inside the mast. This bubble indicates if the mast is correctly aligned, and must be located in the center of device before the mast is installed.

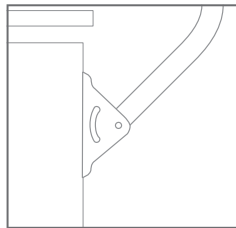

2. Place the mast where you intend to install it. Remember: the mast should point northwest in order to receive the signal.

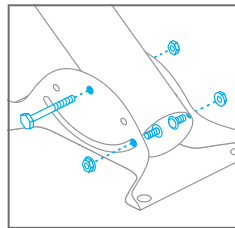

3. Loosen the screws so you can align the mast.

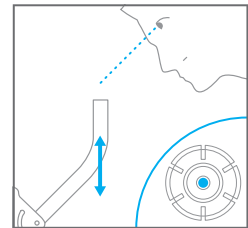

4. Move the mast until the bubble is located directly in the center of the device.

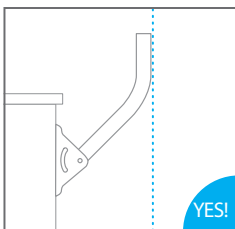

5. Check that the mast is 100% level.

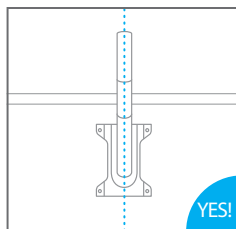

6. Once the mast is perfectly aligned, tighten the screws until the mast locks.

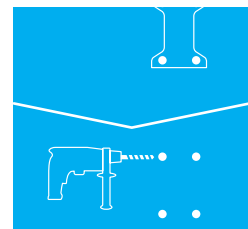

7. Mark on the wall where you will place the mast and then drill.



**IF THE MAST IS NOT PERFECTLY LEVEL, YOU WILL NOT RECEIVE A SIGNAL!**

## 2 Mast installation b. installation

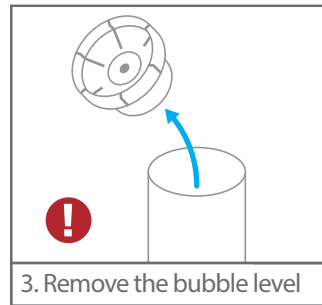
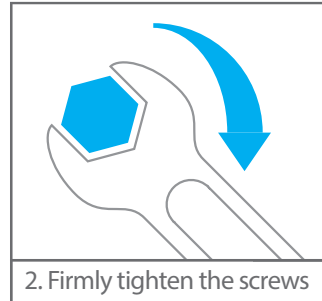
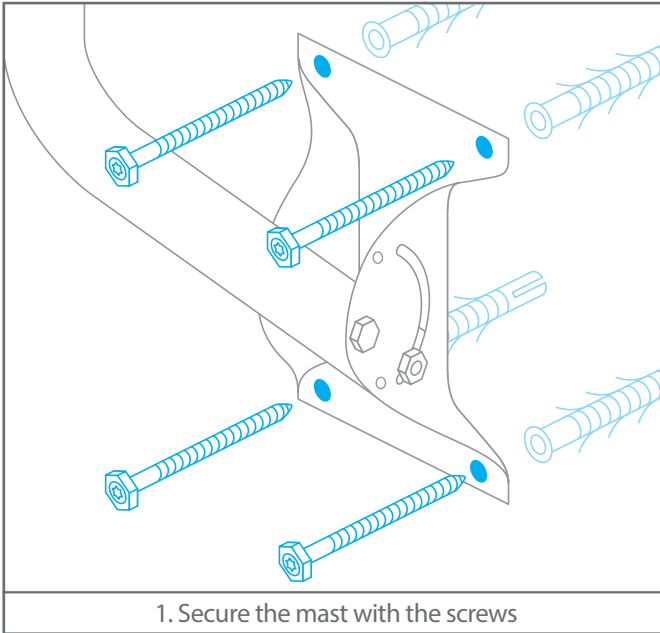

**ATTENTION** Your mast should be installed in a perfectly level position. This is the most important step in setting up your antenna. **IF THE MAST IS NOT LEVEL, YOU WILL NOT RECEIVE A SIGNAL.**

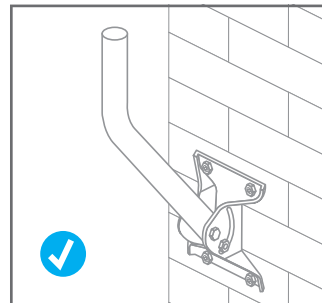

### BEFORE YOU CONTINUE CHECK THE FOLLOWING

- ✓ The mast is 100% level.
- ✓ The screws are firmly tightened.
- ✓ The bubble has been removed from the mast.

■ You're now ready to assemble the dish.

# 3 Installing the dish

## a. how to install the dish

You'll need:

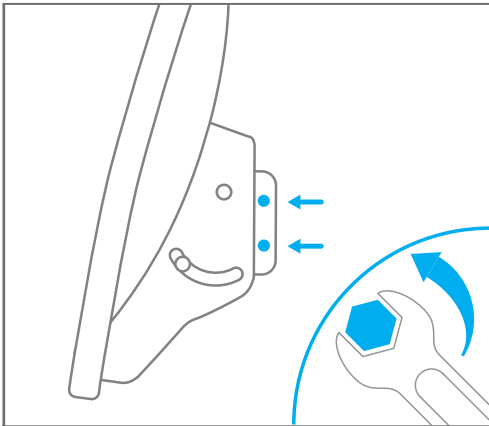

1. Loosen the screws.



Don't tighten  
the screws yet!

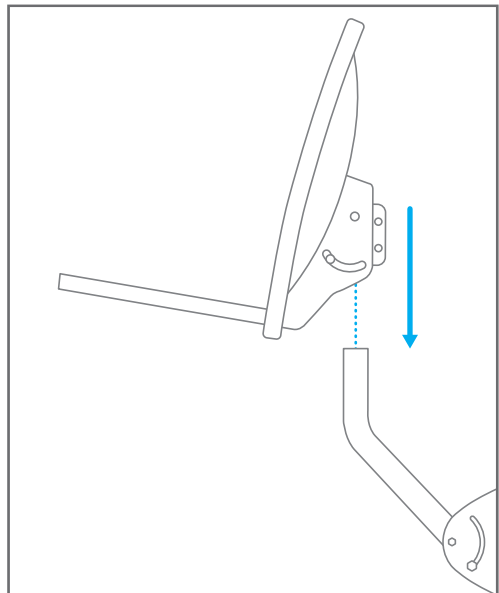

2. Mount the dish on the mast.

# 3 Installing the dish

## b. fasten the dish

1. Loosen these screws

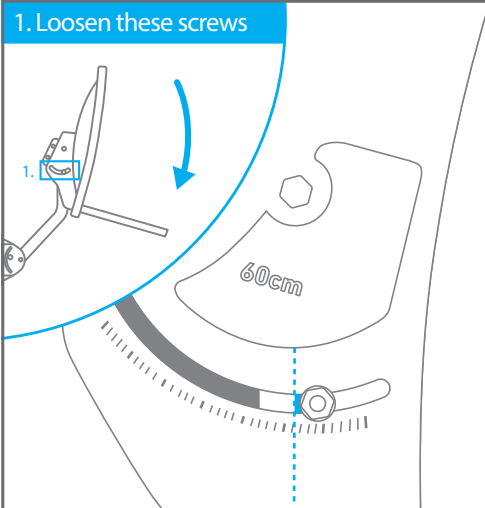

2. You will have to swivel the dish up or down according to your location

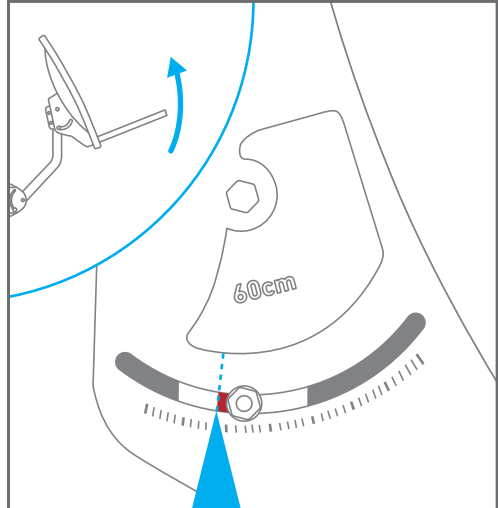

3. Match the color line next to the screw with the number 56.

4.

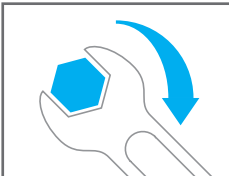

Tighten the screws!

### BEFORE YOU CONTINUE CHECK THE FOLLOWING

- ✓ You've identified the right angle for your location.
- ✓ The red mark on the dish is next to the number that corresponds with your location.
- ✓ The screws are firmly tightened.
- ✓ The antenna is firmly attached to the mast.

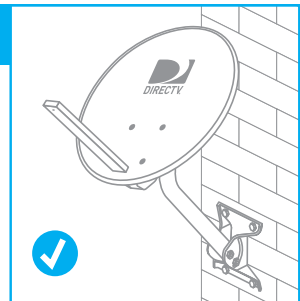



# 4 Cable connection

You'll need:



In this step you will connect everything required to make the system work.

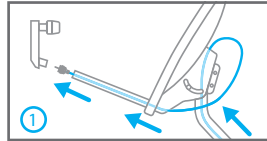

For your safety unplug your TV and receiver. Only plug them back in after connecting the cables.

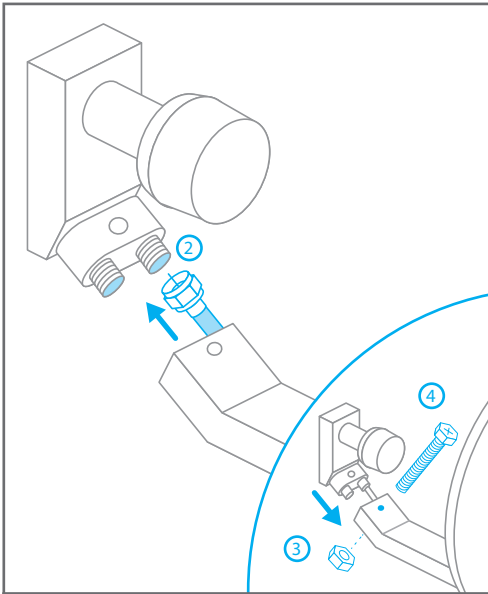

Connect to either of the two connectors!

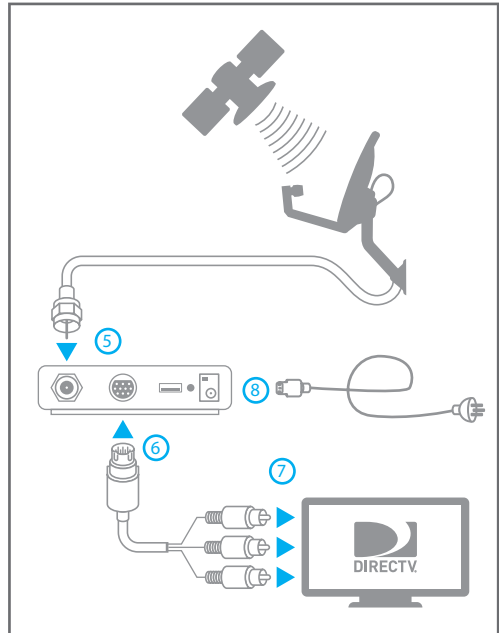

## BEFORE YOU CONTINUE CHECK THE FOLLOWING

- ✓ The LNB receiver should be firmly attached to the LNB arm.
- ✓ All cables and the power cord are connected.



# 5 Locating the signal

## a. configure the receiver

You'll need:



compass



manual



remote control



receiver



11mm  
combination wrench



TV

Turn on your TV and the receiver, and use the remote control to navigate the menu. Read the instructions on the screen, they will be very useful!



Use the arrow buttons to move around the menu.



Press "SELECT" to choose your menu item.



① Go to "English" and press "SELECT"



② Go to "Begin Guided Setup" and press "SELECT"

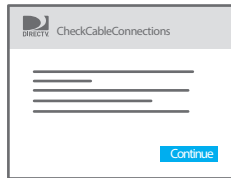

③ Go to "Continue" and press "SELECT"

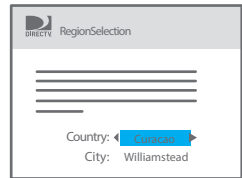

④ Select your country and city and press "SELECT"

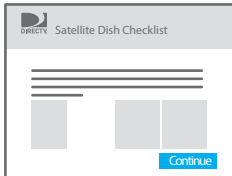

⑤ Go to "Continue" and press "SELECT"



⑥ Go to "Continue" and press "SELECT"

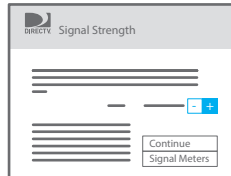

⑦ Use "+" or "-" until you see PR & PR1, then go to "Continue" and press "SELECT".

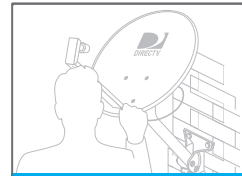

⑧ Proceed to antenna installation to receive the signal.



Now turn your TV volume up to **MAXIMUM**. The following steps will be easier if you place a portable TV next to your antenna.



Do not disconnect or remove the smart card from your receiver.

# 5 Searching for signal

## b. point the antenna toward the satellite

As you saw earlier, your antenna should point towards the satellite, which is located to the southeast.

To do so, use the compass with this manual. Take two steps away from the antenna and place the manual on a flat, level surface.

Remember, if your neighbors have DIRECTV, you can use their antennas as a guide.

TURN THE ANTENNA IN THIS DIRECTION

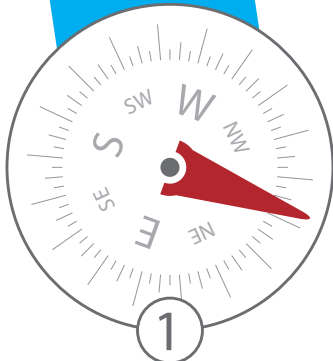
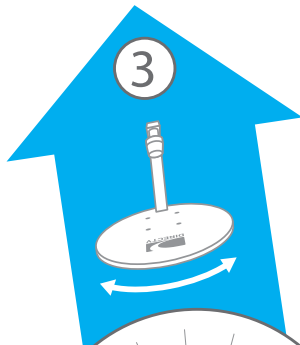

PLACE YOUR COMPASS HERE

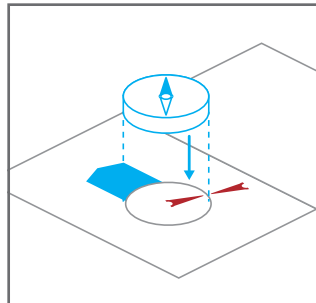

① Place the compass on the drawing on this page.

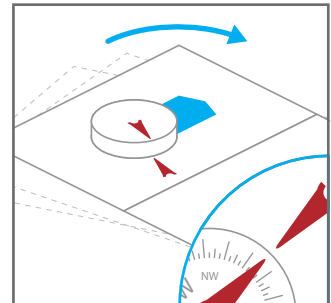

② Turn the manual and compass together until the needle points towards the red mark.

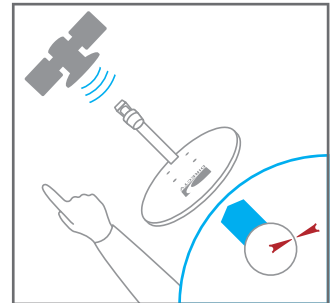

③ Now place your antenna so it's facing the same direction as the blue arrow.

POINT THE RED ARROW HERE



# 5 Searching for signal

## c. listen, turn and point.

1. Turn your antenna from left to right very slowly until the tone speeds up.

You need to have a minimum signal strength of 70%. The higher the better!

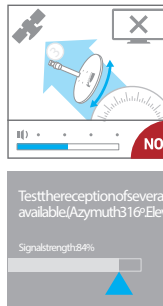
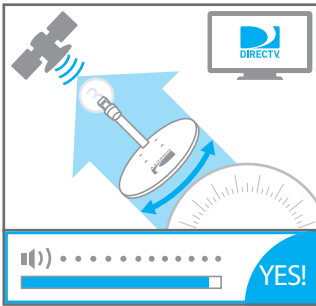

Having someone watching the TV while you move the antenna will make this step faster and easier.

2. Tighten the screws.

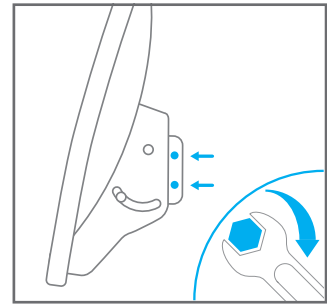

3. Now go back to your TV and continue with the on-screen instructions.

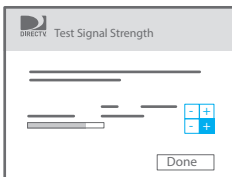

9 Use "+" or "-" until you see PR1, then go to "Done" and press "SELECT"

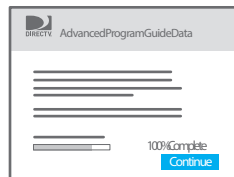

10 When you get 100% signal, go to "Continue" and press "SELECT"



11 Go to "Begin Remote Setup" and press "SELECT"



12 Go to "Watch DIRECTV" and press "SELECT"

## PLEASE CHECK THE FOLLOWING

- ✓ The antenna is pointing towards the satellite.
- ✓ You heard a sharp, quick tone.
- ✓ The signal strength is at least 70%. The higher, the better.

■ CONGRATULATIONS! YOU HAVE COMPLETED INSTALLATION.

Follow the instructions on the back cover and have your card number ready to activate DIRECTV right away.

# 6 Remote control

## a. get familiar with your remote control

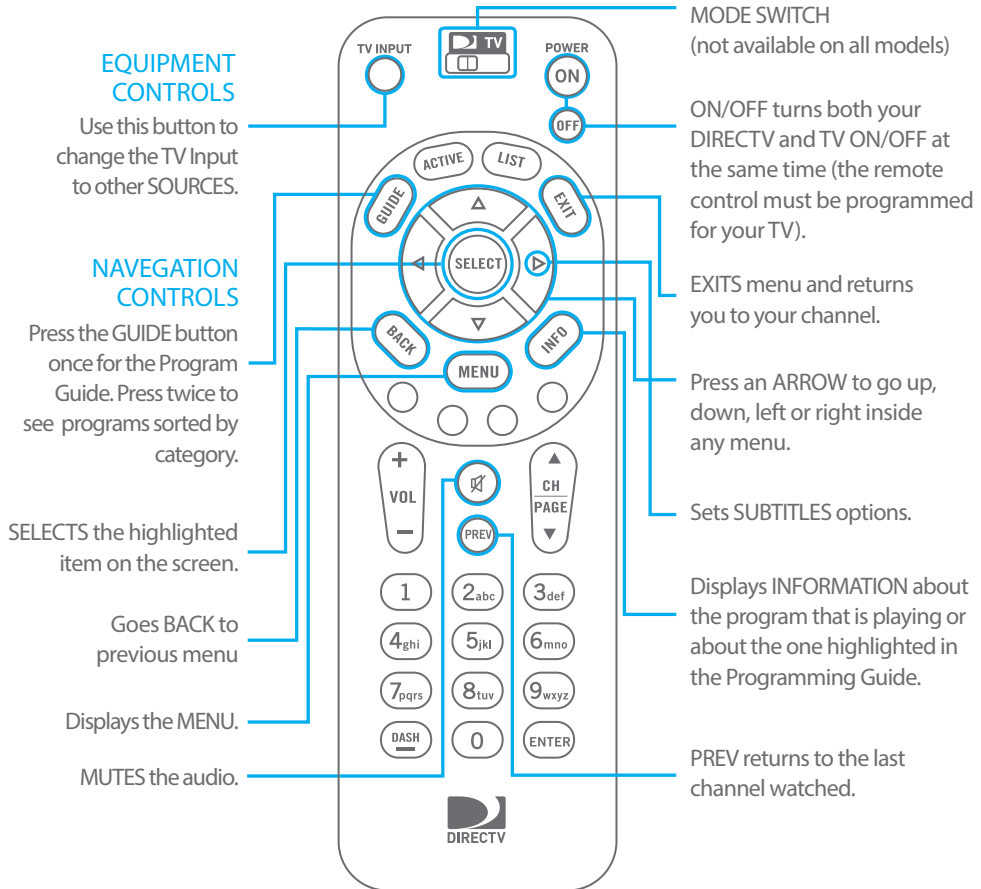

## PROGRAM YOUR REMOTE CONTROL

- ▶ Press **MENU** MENU on the remote control.
- ▶ Select CONFIGURATION.
- ▶ SETTINGS.
- ▶ Remote Control.
- ▶ Follow the on-screen instructions to configure your remote control.

# 7 Channel 100 and on-screen balance a. stay updated

This channel provides information on weekly highlights, gives you DIRECTV programming recommendations, and provides you with the remaining balance in your Prepaid account.

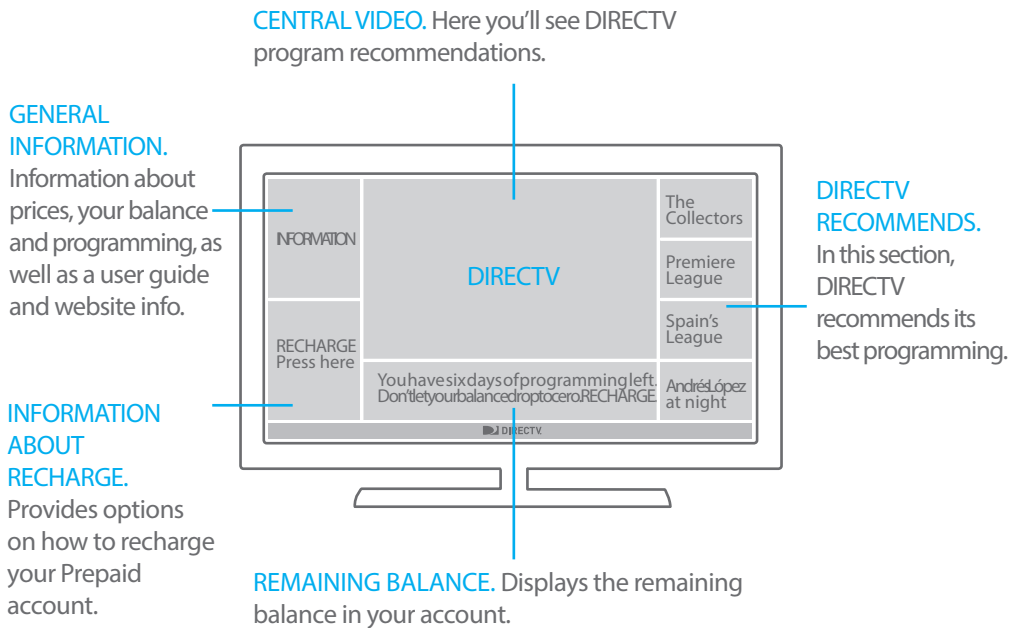

On channel 100 you'll find all the information you need to enjoy the DIRECTV Prepaid experience.



Use the ON/OFF button turn your device on and off.

You can turn the DIRECTV receiver and your TV ON/OFF simultaneously (the remote control must be programmed for your TV).



# 8

## Need help? a. important tips

### Easy Troubleshooting

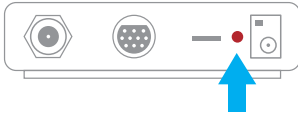

- ▶ To reboot your receiver, press the ● RESET button.

### Do not unplug your receiver, just enjoy the best entertainment.



- ▶ If you unplug the receiver, you might miss an important update which helps to improve our service.
- ▶ The DIRECTV receiver is designed not to consume much energy while not in use.

### Do not remove the smart card from the receiver.



- ▶ Make sure you receive all DIRECTV updates by keeping the smart card inserted in the receiver. If you are a Prepaid customer and want to recharge your card, you must have your card in the receiver.

### How to get your smart card number

- ▶ Press INFO for 3 seconds.

# 9 Activation

## a. call and recharge

### Is everything installed? Activate your kit.

**!** You can find your smart card number by pressing INFO for 3 seconds.

When activating your kit, have this information ready:

1. Have the address where you installed the kit, your ID, email and cell phone number.
2. Find the number of your access card ("ACCES CARD") and receiver ("SERIAL NUMBER").
3. When you are ready for activation call 461 - 4347 between the hours 8am - 5pm, Monday - Saturday.

call



461 - 4347

for more information



<http://www.directvcaribbean.com>

### How do I recharge?

Bring your DIRECTV Prepaid Account Card to any SurePay location.



 **DIRECTV** *PREPAID*